

General Description

The LTP 3565 is a high voltage, low power consumption and high performance LDO. The family uses an advanced CMOS process and a PMOSFET pass device to achieve fast start-up, with high output voltage accuracy. The LTP3565 is stable with a $1.0\mu\text{F}$ ~ $10\mu\text{F}$ ceramic output capacitor, and uses a precision voltage reference and feedback loop to achieve a worst-case accuracy of 2% over all load, line, process, and temperature variations.

Features

- Wide Input Voltage Range: up to 24V
- Output Current: 150mA
- Standard Fixed Output Voltage Options: 3.3V and 5.0V
- More Output Voltage Options Available on Request
- Low I_Q : 1.5 μA Typically
- Low Dropout Voltage
- Short current protection:
- Excellent Load/Line Transient Response
- Available in SOT23-3, SOT23-5, SOT-89 Packages

Order Information (Ordering Number)

Model	Package	Ordering Number ^{Note1}	Packing Option
LTP3565	SOT23-3	LTP3565-xxXT3	Tape and Reel, 3000
	SOT23-5	LTP3565-xxXT5	Tape and Reel, 3000
	SOT23-5(R-Type)	LTP3565-xxRXT5	Tape and Reel, 3000
	SOT89-3	LTP3565-xxXT4	Tape and Reel, 1000
	SOT89-3(R-Type)	LTP3565-xxRXT4	Tape and Reel, 1000

Note1: xx stands for output voltage, e.g. if xx = 18, the output voltage is 1.8V; if xx = 30, the output voltage is 3.0V

Pin Description

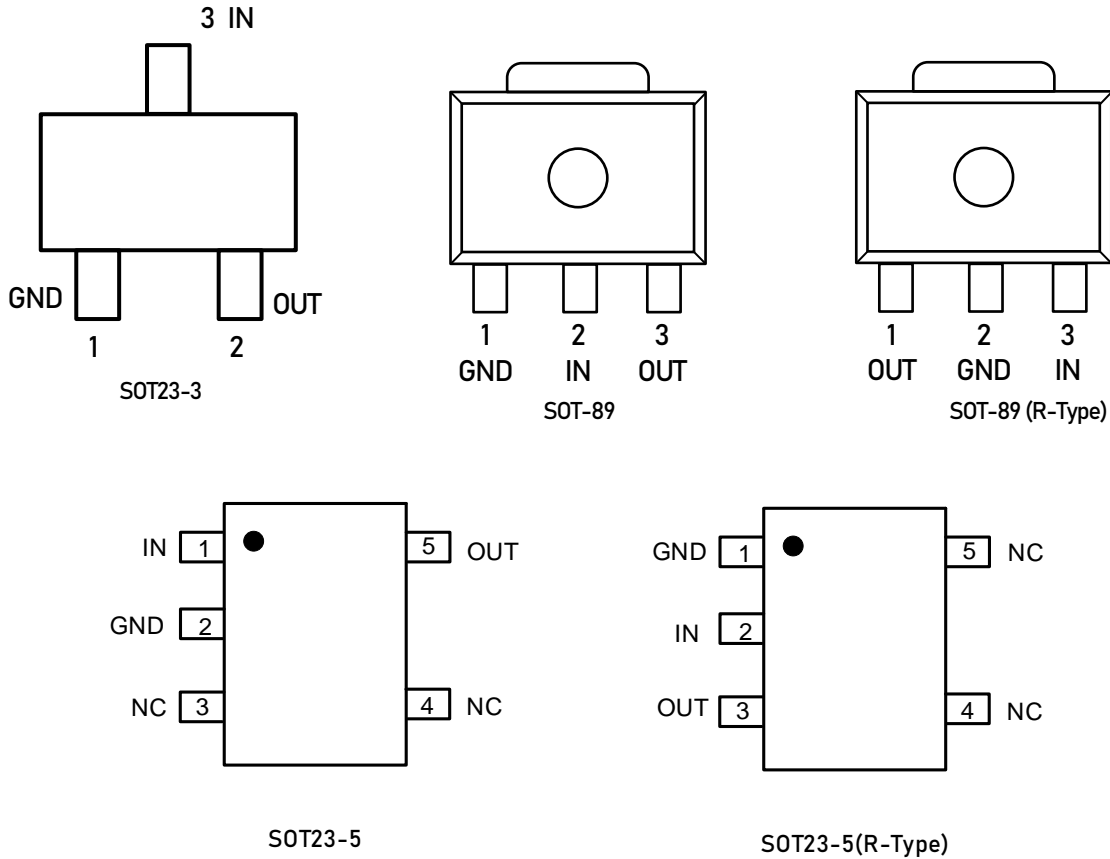

Pin Function

Pin No.					Pin Name	Pin Function
SOT23-3	SOT23-5	SOT23-5(R)	SOT-89	SOT-89(R)		
1	2	1	1	2	GND	Ground.
3	1	2	2	3	IN	Supply input pin. Must be closely decoupled to GND with a 1μF or greater ceramic capacitor.
2	5	3	3	1	OUT	Output pin. Bypass a 1μF or greater ceramic capacitor from this pin to ground.
	3,4	4,5			NC	No connection.

CAUTION: These devices are sensitive to electrostatic discharge; follow proper IC Handling Procedures.
 Linearin and designs are registered trademarks of Linearin Technology Corporation.
 © Copyright Linearin Technology Corporation. All Rights Reserved.
 All other trademarks mentioned are the property of their respective owners.

Block Diagram

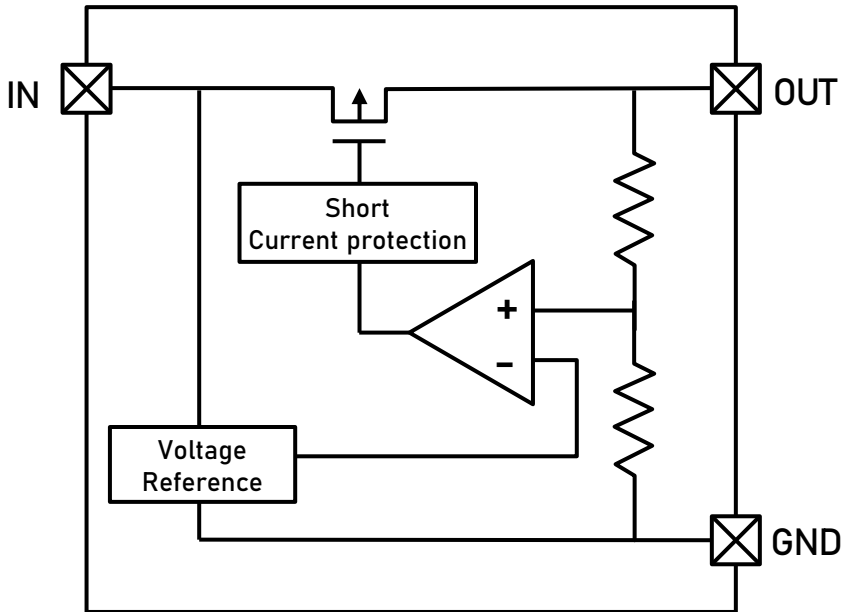

Functional Description

Input Capacitor

A 1 μ F-10 μ F ceramic capacitor is recommended to connect between V_{IN} and GND pins to decouple input power supply glitch and noise. The amount of the capacitance may be increased without limit. This input capacitor must be located as close as possible to the device to assure input stability and less noise. For PCB layout, a wide copper trace is required for both V_{IN} and GND.

Output Capacitor

An output capacitor is required for the stability of the LDO. The recommended output capacitance is from 1 μ F to 10 μ F, Equivalent Series Resistance (ESR) is from 5m Ω to 100m Ω , and temperature characteristics are X7R or X5R. Higher capacitance values help to improve load/line transient response. The output capacitance may be increased to keep low undershoot/overshoot. Place output capacitor as close as possible to OUT and GND pins.

Low Quiescent Current

The LTP3565, consuming only around 1.5 μ A for all input range and output loading, provides great power saving in portable and low power applications.

Short Current Limit Protection

LTP3565 realizes the functions of over-current protection and short-circuit protection. It has 2-level over-current protection threshold. Once the output voltage is greater than 0.7 V, the overcurrent protection function will take effect and the OCP limit current will be set to 180 mA. If the output voltage is lower than 0.7 V, the short-circuit protection function takes effect, and the SCP current is set to 20 mA. Even if the output is short circuited to ground, IC damage can be prevented. When the output is short circuited to ground, the output current will be clamped to I_{SCP} .

Absolute Maximum Ratings

Parameter	Rating	Unit
IN pin to GND pin	-0.3 to 28	V
Thermal Resistance (Junction to Ambient) ⁽¹⁾	SOT89-3	135
	SOT23-3	230
	SOT23-5	250
Junction Temperature	150	°C
Storage Temperature	-65 to 150	°C
Lead Temperature (Soldering, 10 sec)	300	°C
ESD (HBM mode)	ESDA/JEDEC JS-001-2017	±2000V

Note:

(1) This particular frame decreases the total thermal resistance of the package and increases its ability to dissipate power when an appropriate area of copper on the printed circuit board is available for heat-sinking.

(2) Stresses beyond those listed under "ABSOLUTE MAXIMUM RATINGS" may cause permanent damage to the device. These are stress ratings only, and functional operation of the device at these or any other conditions beyond those indicated in the operational sections of the specifications is not implied. Exposure to absolute maximum rating conditions for extended periods may affect device reliability

Electrical Characteristics

$T_a = 25^\circ$

PARAMETER	SYMBOL	TEST CONDITIONS	MIN	TYP	MAX	UNIT
Input Voltage Operation Range	V_{IN}				24	V
Dropout Voltage	V_{DROP}	$V_{OUT} = 3.3V, I_{OUT} = 50mA,$ $\Delta V_{OUT} = +/- 2\% V_{OUT}$	300	360	420	mV
		$V_{OUT} = 3.3V, I_{OUT} = 100mA$	600	700	800	
DC Supply Quiescent Current	I_Q	$I_{OUT} = 0mA, V_{IN} < 28V$		1.5	5	μA
Regulated Output Voltage	V_{OUT}	$I_{OUT} = 1mA$	$V_{OUT} \times 0.98$		$V_{OUT} \times 1.02$	V
Output Voltage Line Regulation	ΔV_{OUT}	$V_{IN} = V_{OUT} + 1V$ to 24V, $I_{OUT} = 10mA$	-15		15	mV
Output Voltage Load Regulation	ΔV_{OUT}	$V_{IN} = V_{OUT} + 1.5V$ to 24V I_{OUT} from 1mA to 100mA	-50		50	mv
Maximum Output Current	I_{OUT}	$V_{IN} = V_{OUT} + 1.5V$		150		mA
Power Supply Rejection Ratio	PSRR	$I_{OUT} = 10mA$	$f = 100Hz$		75	dB
			$f = 1KHz$		55	
Short Current	I_{SHORT}	$V_{OUT} = 0V$		20		mA
Operation Temperature range			-40		85	°C

TYPICAL PERFORMANCE CHARACTERISTICS

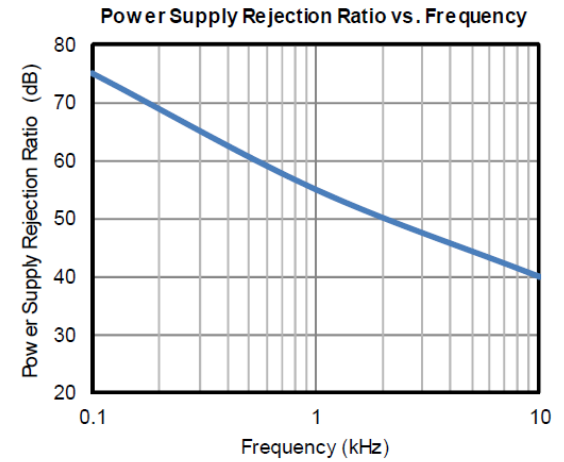
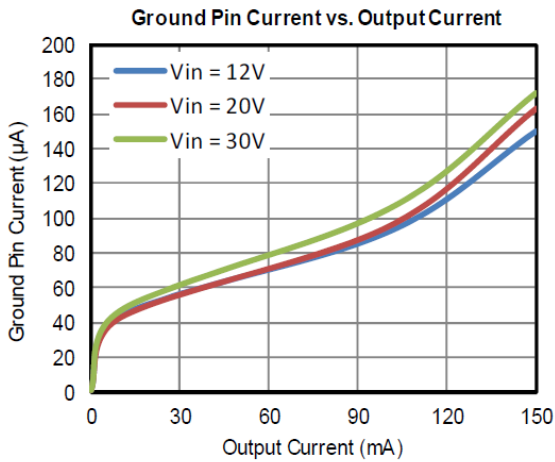
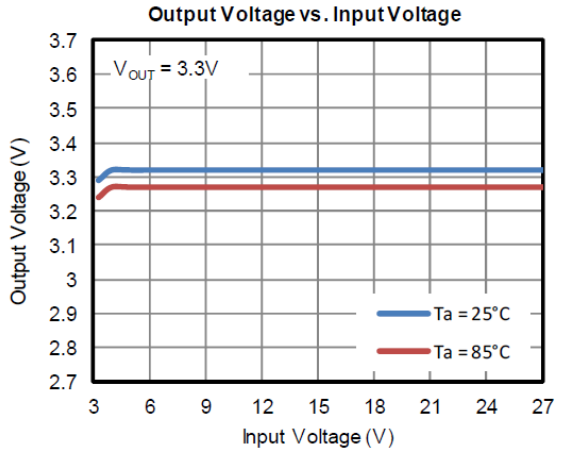
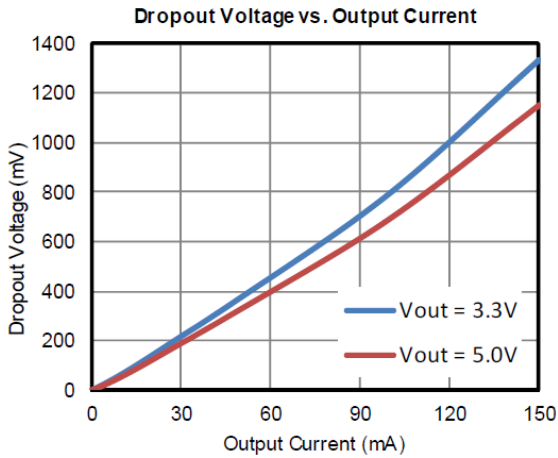
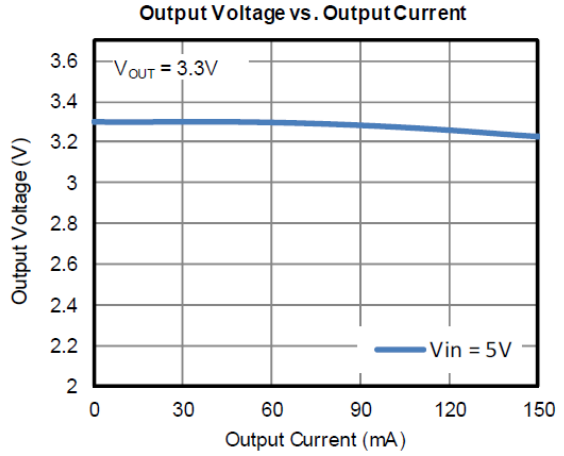
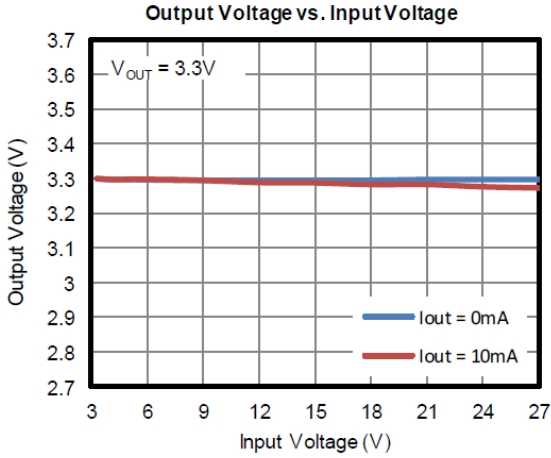

TYPICAL PERFORMANCE CHARACTERISTICS

Load-Transient Response

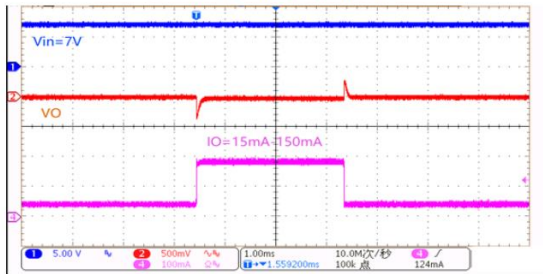

$V_{IN} = 7V, C_{IN} = 1\mu F, C_{OUT} = 1\mu F$

Start up

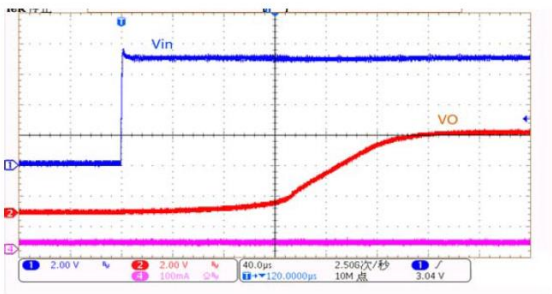

$V_{IN} = 7V, C_{IN} = 1\mu F, C_{OUT} = 1\mu F, \text{Load} = \text{NA}$

Start up

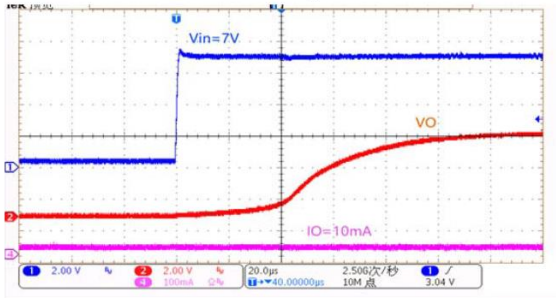

$V_{IN} = 7V, C_{IN} = 1\mu F, C_{OUT} = 1\mu F, \text{Load} = 10\text{mA}$

APPLICATION CIRCUITS

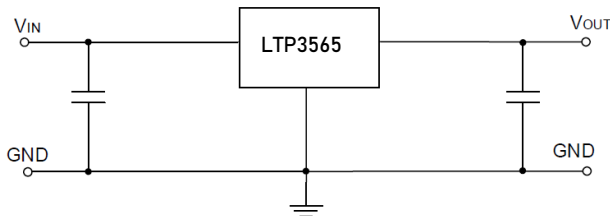

Package Dimension

SOT23-3

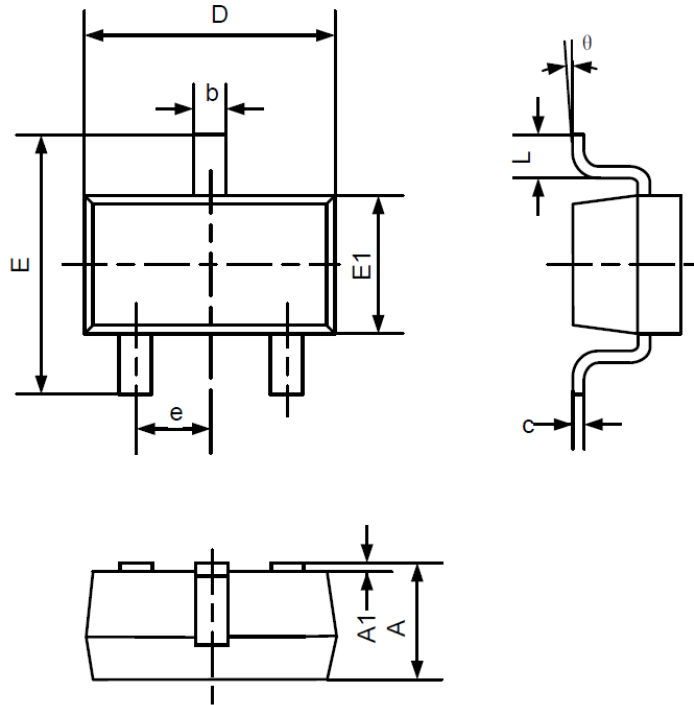

Symbol	Dimensions In Millimeters	
	Min	Max
A	1.050	1.250
A1	0.000	0.100
b	0.300	0.500
c	0.100	0.200
D	2.820	3.020
E	2.650	2.950
E1	1.500	1.700
e	0.950BSC	
L	0.300	0.600
θ	0°	8°

Package Dimension

SOT23-5

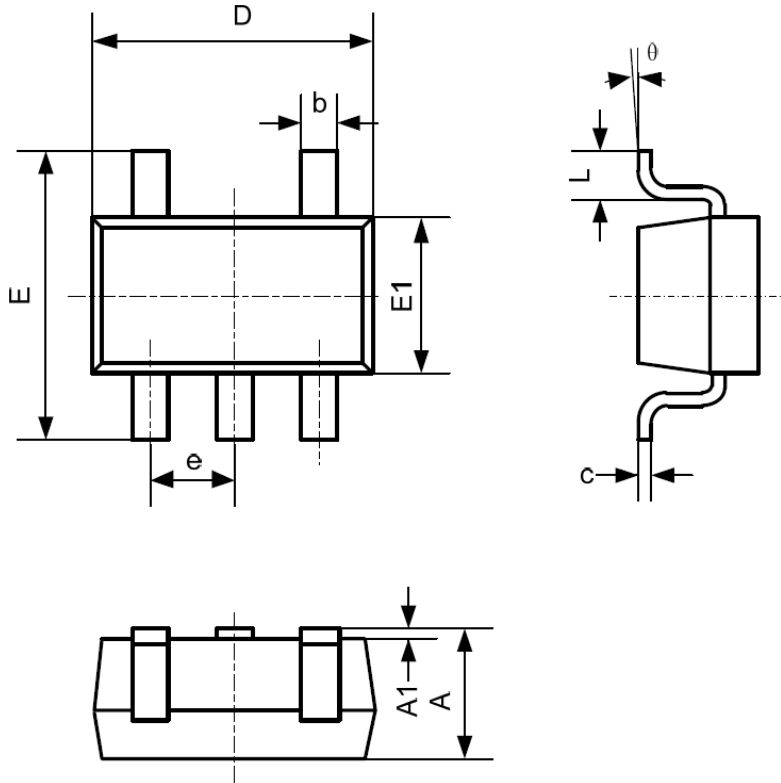

Symbol	Dimensions In Millimeters	
	Min	Max
A	1.05	1.25
A1	0.00	0.10
b	0.35	0.50
c	0.08	0.20
D	2.82	3.02
E	2.60	3.00
E1	1.60	1.70
e	0.95BSC	
L	0.30	0.60
θ	0°	8°

Package Dimension

SOT89-3

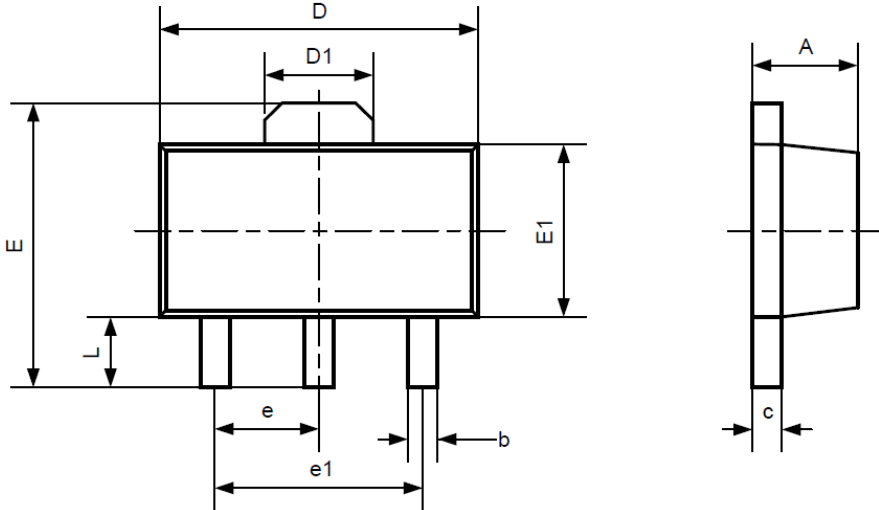

Symbol	Dimensions In Millimeters	
	Min	Max
A	1.400	1.600
b	0.320	0.520
c	0.350	0.440
D	4.400	4.600
D1	1.550REF	
E	3.940	4.250
E1	2.300	2.600
e	1.500BSC	
e1	3.000BSC	
L	0.900	1.200