

General Description

The LTC358H is a general purpose, low positive offset (+1.0 to +2.5 mV), high frequency response and micro-power dual operational amplifier. With an excellent bandwidth of 1MHz, a slew rate of 1 V/ μ s, and a quiescent current of 95 μ A per amplifier at 5 V, the LTC358H can be designed into a wide range of applications.

The LTC358H op-amp is designed to provide optimal performance in low voltage and low power systems. The input common-mode voltage range includes true ground, and with low positive input offset voltage of +1.0 to +2.5 mV. This part provides rail-to-rail output swing into heavy loads. The LTC358H op-amp is specified for single or dual power supplies of 1.8 V to 5.5 V. All models are specified over the extended industrial temperature range of -40°C to +125°C.

The LTC358H is available in both 8-lead SOIC and MSOP packages.

Features and Benefits

- General Purpose 1 MHz Amplifiers, Low Cost
- High Slew Rate: 1 V/ μ s
- Low Positive Offset Voltage: +1.0 to 2.5 mV
- Low Power: 95 μ A per Amplifier Supply Current
- Settling Time to 0.1% with 2V Step: 1.2 μ s
- Unit Gain Stable
- Rail-to-Rail Input and Output
 - Input Voltage Range: -0.1 to +5.1 V at 5V Supply
- Operating Power Supply: +1.8 V to +5.5 V
- Operating Temperature Range: -40 °C to +125 °C
- ESD Rating: HBM – 3 kV, CDM – 2 kV
- Upgrade to LMV358 Op-amp

Applications

- Smoke/Gas/Environment Sensors
- Audio Outputs
- Battery and Power Supply Control
- Portable Equipments and Mobile Devices
- Active Filters
- Sensor Interfaces
- Battery-Powered Instrumentation
- Medical instrumentation

Pin Configurations (Top View)

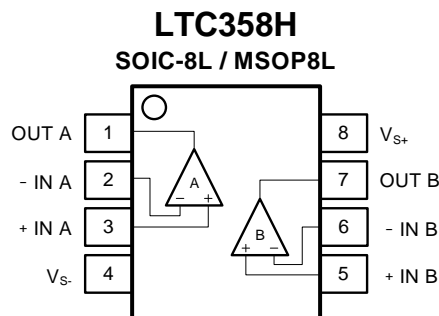

Pin Description

| Symbol | Description |
|----------|--|
| -IN | Inverting input of the amplifier. The voltage range can go from ($V_{S-} - 0.1V$) to ($V_{S+} + 0.1V$). |
| +IN | Non-inverting input of the amplifier. This pin has the same voltage range as -IN. |
| V_{S+} | Positive power supply. The voltage is from 1.8V to 5.5V. Split supplies are possible as long as the voltage between V_{S+} and V_{S-} is between 1.8V and 5.5V. A bypass capacitor of 0.1 μ F as close to the part as possible should be used between power supply pins or between supply pins and ground. |
| V_{S-} | Negative power supply. It is normally tied to ground. It can also be tied to a voltage other than ground as long as the voltage between V_{S+} and V_{S-} is from 1.8V to 5.5V. If it is not connected to ground, bypass it with a capacitor of 0.1 μ F as close to the part as possible. |
| OUT | Amplifier output. |

Ordering Information

| Type Number | Package Name | Package Quantity | Marking Code ⁽¹⁾ |
|---------------|--------------|----------------------|-----------------------------|
| LTC358HXS8/R8 | SOIC-8L | Tape and Reel, 4 000 | 358T |
| LTC358HXV8/R6 | MSOP-8L | Tape and Reel, 3 000 | 358 T |

⁽¹⁾ There may be multiple device markings, a varied marking character of "x", or additional marking, which relates to the logo, the lot trace code information, or the environmental category on the device.

Limiting Value

In accordance with the Absolute Maximum Rating System (IEC 60134).

| Parameter | Absolute Maximum Rating |
|---|--|
| Supply Voltage, V_{S+} to V_{S-} | 10.0 V |
| Signal Input Terminals: Voltage, Current | $V_{S-} - 0.3 V$ to $V_{S+} + 0.3 V$, ± 10 mA |
| Output Short-Circuit | Continuous |
| Storage Temperature Range, T_{stg} | -65 °C to +150 °C |
| Junction Temperature, T_J | 150 °C |
| Lead Temperature Range (Soldering 10 sec) | 260 °C |

ESD Rating

| Parameter | Item | Value | Unit |
|---------------------------------|--|--------------|------|
| Electrostatic Discharge Voltage | Human body model (HBM), per ANSI/ESDA/JEDEC JS-001 | $\pm 3\ 000$ | V |
| | Charged device model (CDM), per ANSI/ESDA/JEDEC JS-002 | $\pm 2\ 000$ | |

Electrical Characteristics

$V_S = 5.0V$, $T_A = +25^\circ C$, $V_{CM} = V_S/2$, $V_O = V_S/2$, and $R_L = 10k\Omega$ connected to $V_S/2$, unless otherwise noted.

Boldface limits apply over the specified temperature range, $T_A = -40$ to $+125^\circ C$.

| Symbol | Parameter | Conditions | Min. | Typ. | Max. | Unit |
|-------------------------------|-----------------------------------|--|----------------|---------------|----------------|------------------|
| INPUT CHARACTERISTICS | | | | | | |
| V_{OS} | Input offset voltage | | +1.0 | +1.6 | +2.5 | mV |
| $V_{OS\ TC}$ | Offset voltage drift | over Temperature | | 2 | | $\mu V/^\circ C$ |
| I_B | Input bias current | $T_A = +85^\circ C$ | | 150 | | pA |
| | | $T_A = +125^\circ C$ | | 500 | | |
| I_{OS} | Input offset current | | | 5 | | pA |
| V_{CM} | Common-mode voltage range | | $V_{S-} - 0.1$ | | $V_{S+} + 0.1$ | V |
| CMRR | Common-mode rejection ratio | $V_S = 5.5V$, $V_{CM} = -0.1$ to $5.6V$ | 80 | 96 | | dB |
| | | $V_{CM} = 0$ to $5.3V$, $T_A = -40$ to $+125^\circ C$ | 70 | | | |
| | | $V_S = 2.0V$, $V_{CM} = -0.1$ to $2.1V$ | 74 | 88 | | |
| | | $V_{CM} = 0$ to $1.8V$, $T_A = -40$ to $+125^\circ C$ | 65 | | | |
| A_{VOL} | Open-loop voltage gain | $R_L = 10k\Omega$, $V_O = 0.05$ to $3.5V$ | 90 | 105 | | dB |
| | | $T_A = -40$ to $+125^\circ C$ | 85 | | | |
| R_{IN} | Input resistance | | 100 | | | G Ω |
| C_{IN} | Input capacitance | Differential | | 2.0 | | pF |
| | | Common mode | | 3.5 | | |
| OUTPUT CHARACTERISTICS | | | | | | |
| V_{OH} | High output voltage swing | $R_L = 10k\Omega$ | $V_{S-} - 19$ | $V_{S+} - 11$ | | mV |
| V_{OL} | Low output voltage swing | $R_L = 10k\Omega$ | | $V_{S-} + 8$ | $V_{S+} + 14$ | mV |
| Z_{OUT} | Closed-loop output impedance | $f = 200kHz$, $G = +1$ | | 0.4 | | Ω |
| | Open-loop output impedance | $f = 1MHz$, $I_O = 0$ | | 2.6 | | |
| I_{SC} | Short-circuit current | Source current through 10Ω | | 45 | | mA |
| | | Sink current through 10Ω | | 55 | | |
| DYNAMIC PERFORMANCE | | | | | | |
| GBW | Gain bandwidth product | $f = 1kHz$ | | 1 | | MHz |
| Φ_M | Phase margin | $C_L = 100pF$ | | 66 | | $^\circ$ |
| SR | Slew rate | $G = +1$, $C_L = 100pF$, $V_O = 1.5V$ to $3.5V$ | | 1.0 | | V/ μs |
| t_S | Settling time | To 0.1%, $G = +1$, 2V step | | 1.2 | | μs |
| | | To 0.01%, $G = +1$, 2V step | | 1.5 | | |
| t_{OR} | Overload recovery time | $V_{IN} * Gain > V_S$ | | 2 | | μs |
| THD+N | Total harmonic distortion + noise | $f = 1kHz$, $G = +1$, $V_O = 3V_{PP}$ | | 0.002 | | % |
| NOISE PERFORMANCE | | | | | | |
| V_n | Input voltage noise | $f = 0.1$ to $10Hz$ | | 6 | | μV_{P-P} |
| e_n | Input voltage noise density | $f = 1kHz$ | | 30 | | nV/ \sqrt{Hz} |

Electrical Characteristics (continued)

$V_S = 5.0V$, $T_A = +25^\circ C$, $V_{CM} = V_S/2$, $V_O = V_S/2$, and $R_L = 10k\Omega$ connected to $V_S/2$, unless otherwise noted.

Boldface limits apply over the specified temperature range, $T_A = -40$ to $+125^\circ C$.

| Symbol | Parameter | Conditions | Min. | Typ. | Max. | Unit |
|--------------------------------|-----------------------------------|--|------|------|------|-----------------|
| I_n | Input current noise density | $f = 10kHz$ | | 10 | | fA/ \sqrt{Hz} |
| POWER SUPPLY | | | | | | |
| V_S | Operating supply voltage | | 1.8 | | 5.5 | V |
| PSRR | Power supply rejection ratio | $V_S = 2.0$ to 5.5 V, $V_{CM} < V_{S+} - 2V$ | 80 | 106 | | dB |
| | | $T_A = -40$ to $+125^\circ C$ | 75 | | | |
| I_q | Quiescent current (per amplifier) | | | 95 | 135 | μA |
| | | $T_A = -40$ to $+125^\circ C$ | | | 170 | |
| THERMAL CHARACTERISTICS | | | | | | |
| T_A | Operating temperature range | | -40 | | +125 | $^\circ C$ |
| θ_{JA} | Package Thermal Resistance | SOIC-8L | | 125 | | $^\circ C/W$ |
| | | MSOP-8L | | 216 | | |

Typical Performance Characteristics

At $T_A = +25^\circ\text{C}$, $V_{CM} = V_S/2$, and $R_L = 10\text{k}\Omega$ connected to $V_S/2$, unless otherwise noted.

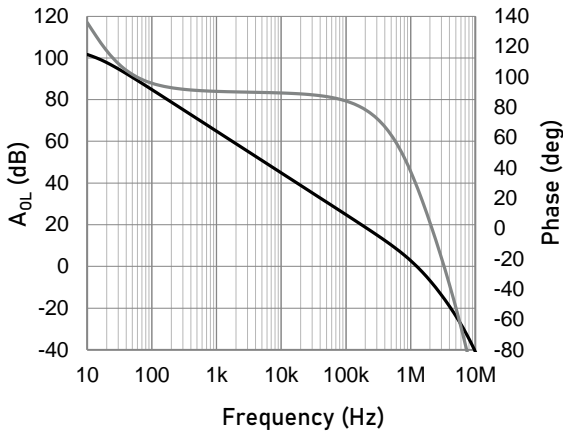

Open-loop Gain and Phase as a function of Frequency.

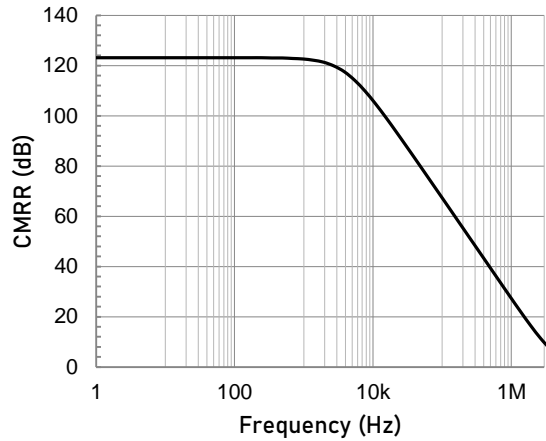

Common-mode Rejection Ratio as a function of Frequency.

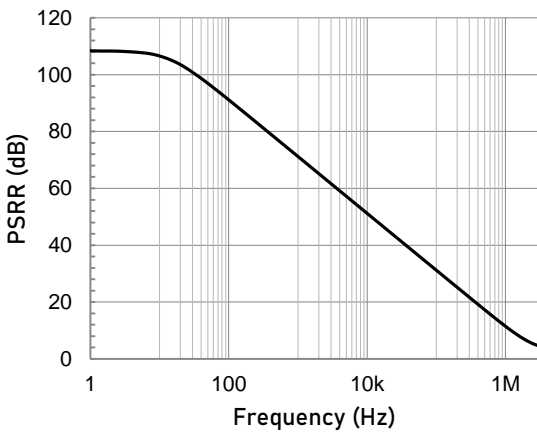

Power Supply Rejection Ratio as a function of Frequency.

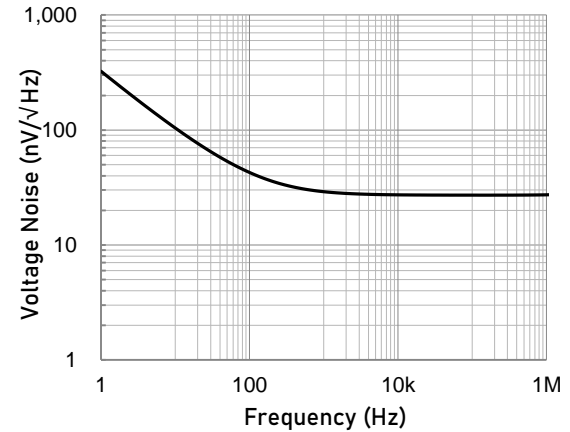

Input Voltage Noise Spectral Density as a function of Frequency.

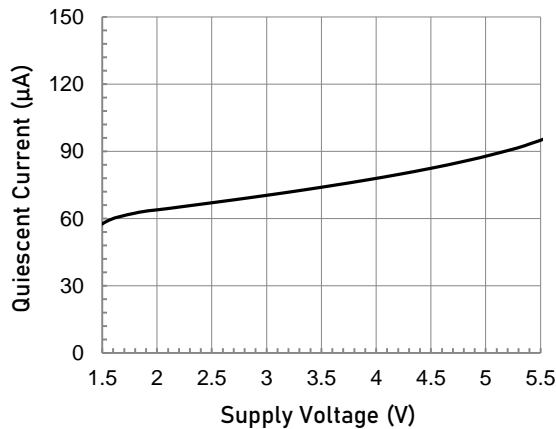

Quiescent Current as a function of Supply Voltage.

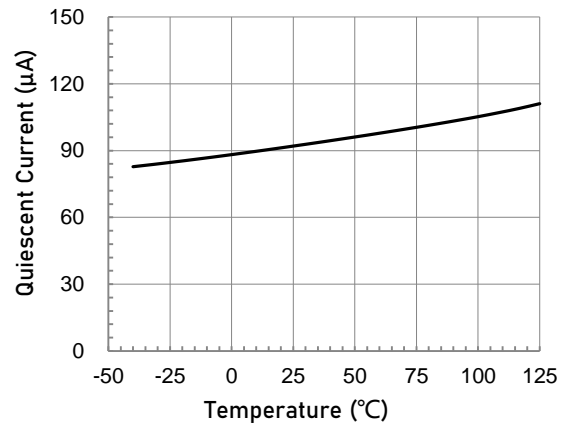

Quiescent Current as a function of Temperature.

Typical Performance Characteristics (continued)

At $T_A = +25^\circ\text{C}$, $V_{CM} = V_S/2$, and $R_L = 10\text{k}\Omega$ connected to $V_S/2$, unless otherwise noted.

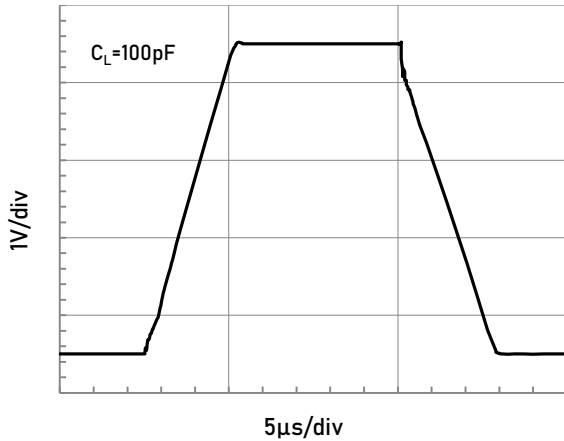

Large Signal Step Response.

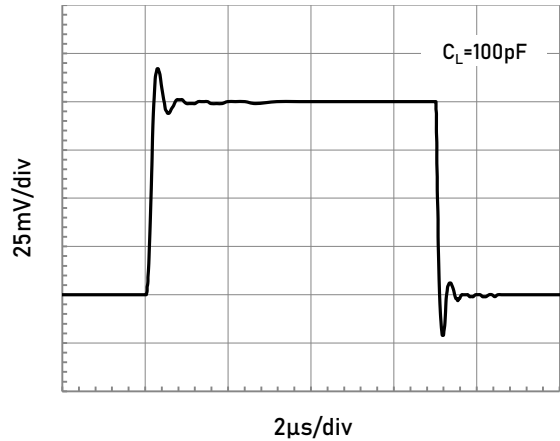

Small Signal Step Response.

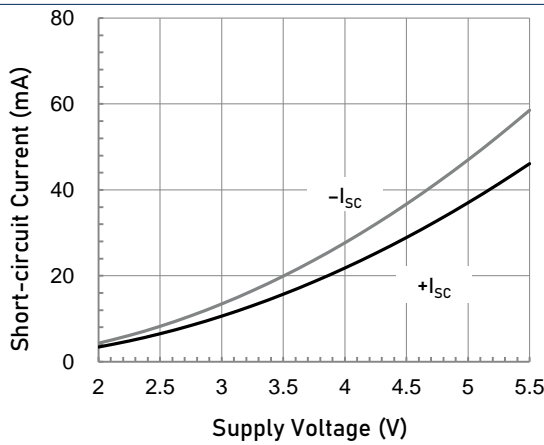

Short-circuit Current as a function of Supply Voltage.

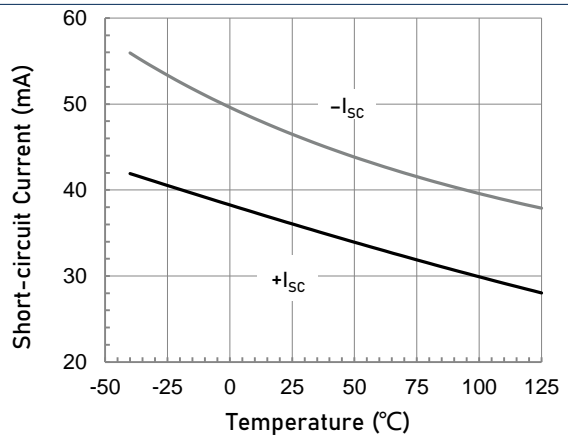

Short-circuit Current as a function of Temperature.

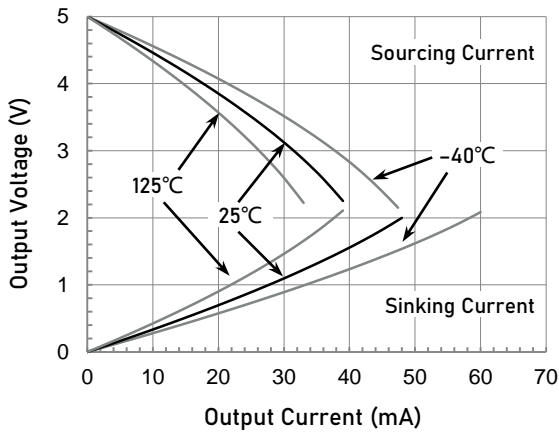

Output Voltage Swing as a function of Output Current.

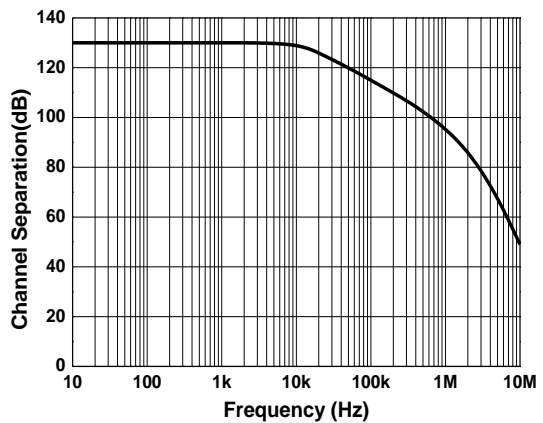

Channel Separation as a function of Frequency.

CAUTION: These devices are sensitive to electrostatic discharge; follow proper IC Handling Procedures.
 Linearin and designs are registered trademarks of Linearin Technology Corporation.
 © Copyright Linearin Technology Corporation. All Rights Reserved.
 All other trademarks mentioned are the property of their respective owners.

Application Notes

LOW INPUT BIAS CURRENT

The LTC358H device is a CMOS op-amp and features very low input bias current in pA range. The low input bias current allows the amplifiers to be used in applications with high resistance sources. Care must be taken to minimize PCB Surface Leakage. See below section on "PCB Surface Leakage" for more details.

PCB SURFACE LEAKAGE

In applications where low input bias current is critical, Printed Circuit Board (PCB) surface leakage effects need to be considered. Surface leakage is caused by humidity, dust or other contamination on the board. Under low humidity conditions, a typical resistance between nearby traces is $10^{12}\Omega$. A 5V difference would cause 5pA of current to flow, which is greater than the LTC358H's input bias current at +25°C (1fA, typical). It is recommended to use multi-layer PCB layout and route the op-amp's -IN and +IN signal under the PCB surface.

The effective way to reduce surface leakage is to use a guard ring around sensitive pins (or traces). The guard ring is biased at the same voltage as the sensitive pin. An example of this type of layout is shown in Figure 1 for Inverting Gain application.

- For Non-Inverting Gain and Unity-Gain Buffer:
 - Connect the non-inverting pin (+IN) to the input with a wire that does not touch the PCB surface.
 - Connect the guard ring to the inverting input pin (-IN). This biases the guard ring to the Common Mode input voltage.
- For Inverting Gain and Trans-impedance Gain Amplifiers (convert current to voltage, such as photo detectors):
 - Connect the guard ring to the non-inverting input pin (+IN). This biases the guard ring to the same reference voltage as the op-amp (e.g., $V_S/2$ or ground).
 - Connect the inverting pin (-IN) to the input with a wire that does not touch the PCB surface.

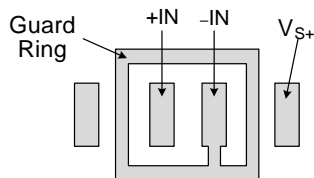

Figure 1. Use a guard ring around sensitive pins

GROUND SENSING AND RAIL TO RAIL

The input common-mode voltage range of the LTC358H op-amp extends 100mV beyond the supply rails. This is achieved with a complementary input stage—an N-channel input differential pair in parallel with a P-channel differential pair. For normal operation, inputs should be limited to this range. The absolute maximum input voltage is 500mV beyond the supplies. Inputs greater than the input common-mode range but less than the maximum input voltage, while not valid, will not cause any damage to the op-amp. Unlike some other op-amps, if input current is limited, the inputs may go beyond the supplies without phase inversion, as shown in Figure 2. Since the input common-mode range extends from $(V_{S-} - 0.1V)$ to $(V_{S+} + 0.1V)$, the LTC358H op-amp can easily perform 'true ground' sensing.

A topology of class AB output stage with common-source transistors is used to achieve rail-to-rail output. For light

resistive loads (e.g. 100k Ω), the output voltage can typically swing to within 5mV from the supply rails. Different load conditions change the ability of the amplifier to swing close to the rails. For resistive loads up to 10-k Ω , the output swings typically to within 11-mV of the positive supply rail and within 8-mV of the negative supply rail.

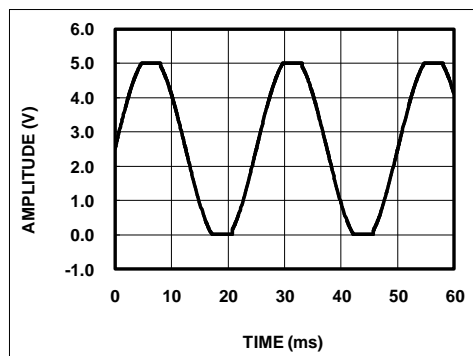

Figure 2. No Phase Inversion with Inputs Greater Than the Power-Supply Voltage

The maximum output current is a function of total supply voltage. As the supply voltage to the amplifier increases, the output current capability also increases. Attention must be paid to keep the junction temperature of the IC below 150°C when the output is in continuous short-circuit. The output of the amplifier has reverse-biased ESD diodes connected to each supply. The output should not be forced more than 0.5V beyond either supply, otherwise current will flow through these diodes.

CAPACITIVE LOAD AND STABILITY

The LTC358H op-amp can directly drive 500pF in unity-gain without oscillation. The unity-gain follower (buffer) is the most sensitive configuration to capacitive loading. Direct capacitive loading reduces the phase margin of amplifiers and this results in ringing or even oscillation. Applications that require greater capacitive drive capability should use an isolation resistor between the output and the capacitive load like the circuit in Figure 3. The isolation resistor R_{ISO} and the load capacitor C_L form a zero to increase stability. The bigger the R_{ISO} resistor value, the more stable V_{OUT} will be. Note that this method results in a loss of gain accuracy because R_{ISO} forms a voltage divider with the R_L .

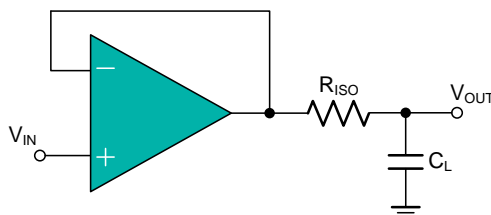

Figure 3. Indirectly Driving Heavy Capacitive Load

An improvement circuit is shown in Figure 4. It provides DC accuracy as well as AC stability. The R_F provides the DC accuracy by connecting the inverting signal with the output. The C_F and R_{ISO} serve to counteract the loss of phase margin by feeding the high frequency component of the output signal back to the amplifier's inverting input, thereby preserving phase margin in the overall feedback loop.

Application Notes (continued)

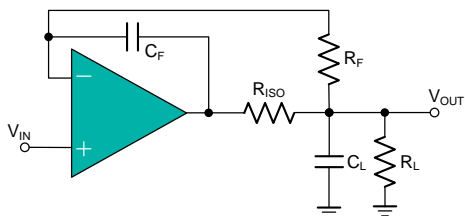

Figure 4. Indirectly Driving Heavy Capacitive Load with DC Accuracy

For no-buffer configuration, there are two other ways to increase the phase margin: (a) by increasing the amplifier's gain, or (b) by placing a capacitor in parallel with the feedback resistor to counteract the parasitic capacitance associated with inverting node.

POWER SUPPLY LAYOUT AND BYPASS

The LTC358H op-amp operates from either a single +1.8V to +5.5V supply or dual $\pm 0.9V$ to $\pm 2.75V$ supplies. For single-supply operation, bypass the power supply V_S with a ceramic capacitor (i.e. 0.01 μF to 0.1 μF) which should be placed close (within 2mm for good high frequency performance) to the V_S pin. For dual-supply operation, both the V_{S+} and the V_{S-} supplies should be bypassed to ground

with separate 0.1 μF ceramic capacitors. A bulk capacitor (i.e. 2.2 μF or larger tantalum capacitor) within 100mm to provide large, slow currents and better performance. This bulk capacitor can be shared with other analog parts.

Good PC board layout techniques optimize performance by decreasing the amount of stray capacitance at the op-amp's inputs and output. To decrease stray capacitance, minimize trace lengths and widths by placing external components as close to the device as possible. Use surface-mount components whenever possible. For the op-amp, soldering the part to the board directly is strongly recommended. Try to keep the high frequency big current loop area small to minimize the EMI (electromagnetic interfacing).

GROUNDING

A ground plane layer is important for the LTC358H circuit design. The length of the current path speed currents in an inductive ground return will create an unwanted voltage noise. Broad ground plane areas will reduce the parasitic inductance.

INPUT-TO-OUTPUT COUPLING

To minimize capacitive coupling, the input and output signal traces should not be parallel. This helps reduce unwanted positive feedback.

Typical Application Circuits

DIFFERENTIAL AMPLIFIER

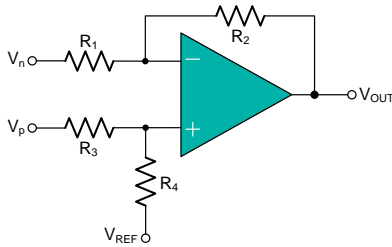

Figure 5. Differential Amplifier

The circuit shown in Figure 5 performs the difference function. If the resistors ratios are equal $R_4/R_3 = R_2/R_1$, then:

$$V_{OUT} = (V_p - V_n) \times R_2/R_1 + V_{REF}$$

INSTRUMENTATION AMPLIFIER

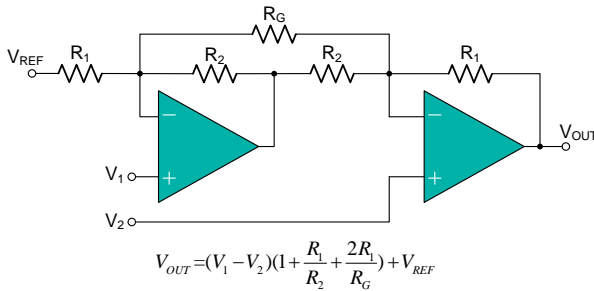
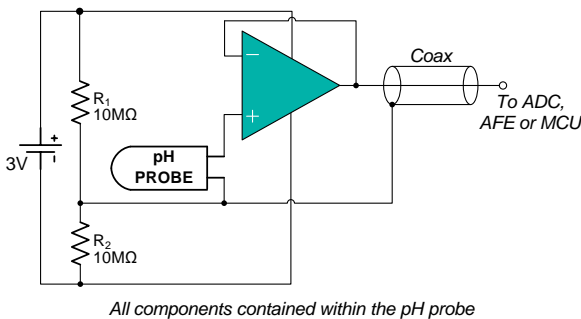

Figure 6. Instrumentation Amplifier

The LTC358H op-amp is well suited for conditioning sensor signals in battery-powered applications. Figure 6 shows a two op-amp instrumentation amplifier, using the LTC358H op-amp. The circuit works well for applications requiring rejection of common-mode noise at higher gains. The reference voltage (V_{REF}) is supplied by a low-impedance source. In single voltage supply applications, the V_{REF} is typically $V_S/2$.

BUFFERED CHEMICAL SENSORS



All components contained within the pH probe

Figure 7. Buffered pH Probe

The LTC358H op-amp has input bias current in the pA range. This is ideal in buffering high impedance chemical sensors, such as pH probes. As an example, the circuit in Figure 7 eliminates expansive low-leakage cables that is required to connect a pH probe (general purpose combination pH probes, e.g Corning 476540) to metering ICs such as ADC, AFE and/or MCU. A LTC358H op-amp and a lithium battery are housed in the probe assembly. A conventional low-cost coaxial cable can be used to carry the op-amp's output signal to subsequent ICs for pH reading.

SHUNT-BASED CURRENT SENSING AMPLIFIER

The current sensing amplification shown in Figure 8 has a slew rate of $2\pi fV_{PP}$ for the output of sine wave signal, and has a slew rate of $2fV_{PP}$ for the output of triangular wave signal. In most of motor control systems, the PWM frequency is at 10kHz to 20kHz, and one cycle time is 100μs for a 10kHz of PWM frequency. In current shunt monitoring for a motor phase, the phase current is converted to a phase voltage signal for ADC sampling. This sampling voltage signal must be settled before entering the ADC. As the Figure 8 shown, the total settling time of a current shunt monitor circuit includes: the rising edge delay time (t_{SR}) due to the op-amp's slew rate, and the measurement settling time (t_{SET}). For a 3-shunt solution in motor phase current sensing, if the smaller duty cycle of the PWM is defined at 45% (In fact, the phase with minimum PWM duty cycle, such as 5%, is not detected current directly, and it can be calculated from the other two phase currents), and the t_{SR} is required at 20% of a total time window for a phase current monitoring, in case of a 3.3V motor control system (3.3V MCU with 12-bit ADC), the op-amp's slew rate should be more than:

$$3.3V / (100\mu s \times 45\% \times 20\%) = 0.37 V/\mu s$$

At the same time, the op-amp's bandwidth should be much greater than the PWM frequency, like 10 time at least.

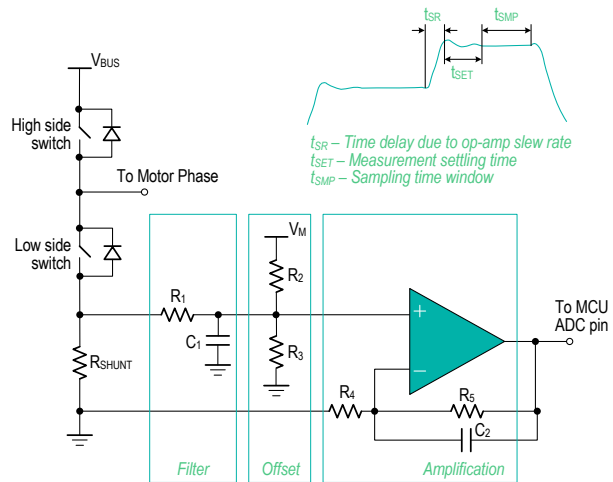
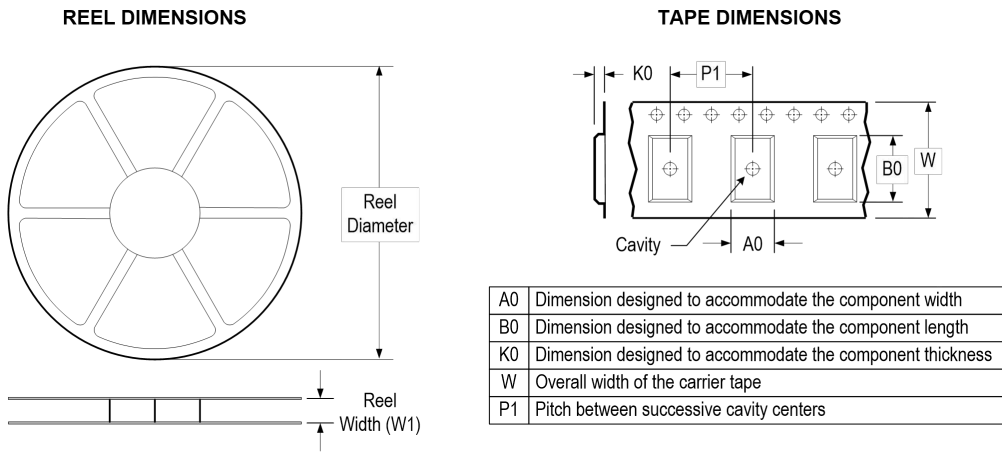
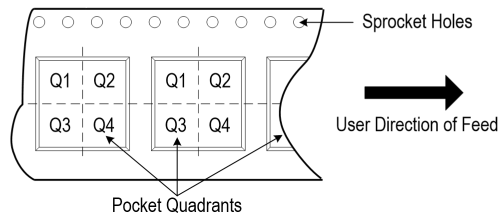

Figure 8. Current Shunt Monitor Circuit

Tape and Reel Information



QUADRANT ASSIGNMENTS FOR PIN 1 ORIENTATION IN TAPE



*All dimensions are nominal

| Device | Package Type | Pins | SPQ | Reel Diameter (mm) | Reel Width W1 (mm) | A0 (mm) | B0 (mm) | K0 (mm) | P1 (mm) | W (mm) | Pin 1 Quadrant |
|---------------|--------------|------|-------|--------------------|--------------------|---------|---------|---------|---------|--------|----------------|
| LTC358HXS8/R8 | SOIC | 8 | 4 000 | 330 | 12.5 | 6.6 | 5.3 | 2.0 | 8.0 | 12.0 | Q1 |
| LTC358HXV8/R6 | MSOP | 8 | 3 000 | 330 | 12.5 | 5.0 | 3.5 | 2.0 | 8.0 | 12.0 | Q1 |

Package Outlines

DIMENSIONS, SOIC-8L

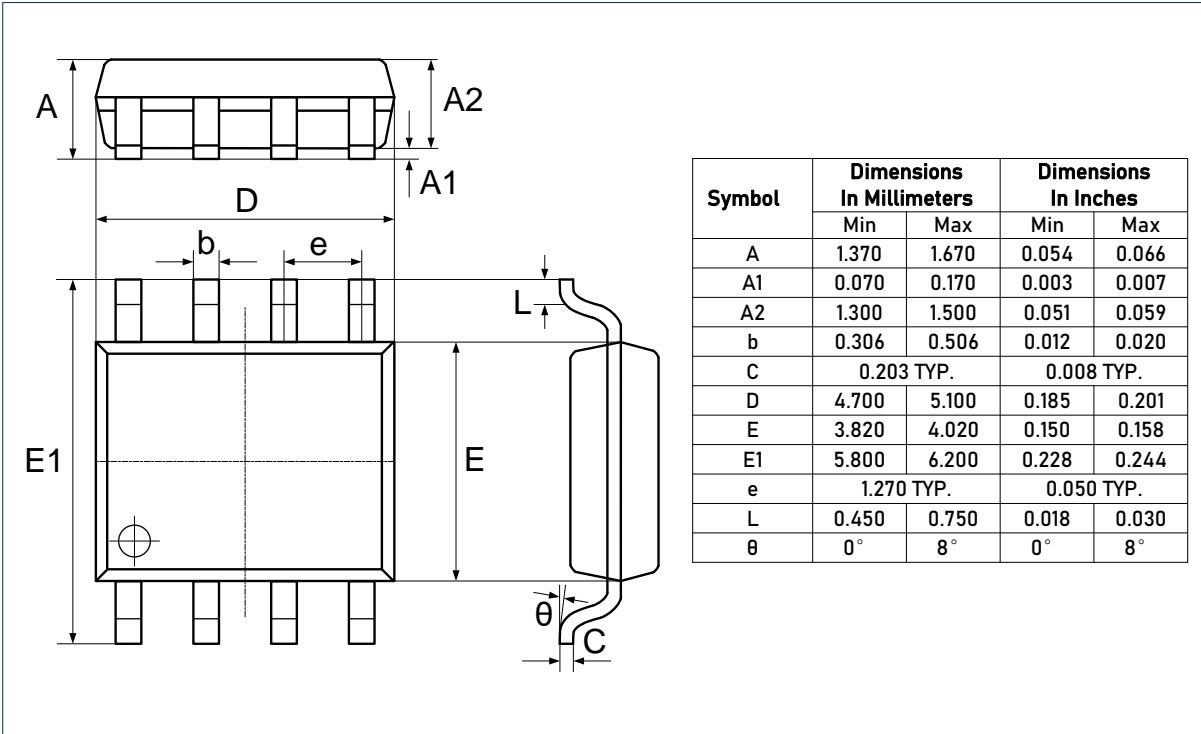

RECOMMENDED SOLDERING FOOTPRINT, SOIC-8L

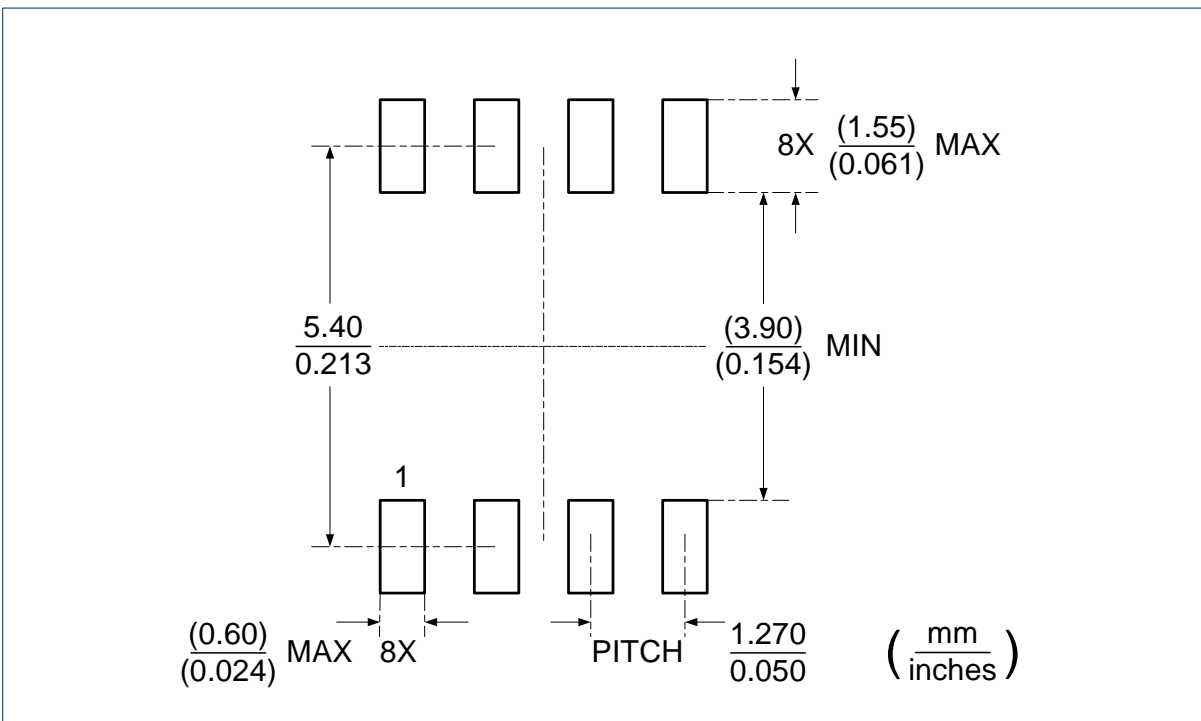

CAUTION: These devices are sensitive to electrostatic discharge; follow proper IC Handling Procedures.
 Linearin and designs are registered trademarks of Linearin Technology Corporation.
 © Copyright Linearin Technology Corporation. All Rights Reserved.
 All other trademarks mentioned are the property of their respective owners.

Package Outlines (continued)

DIMENSIONS, MSOP-8L

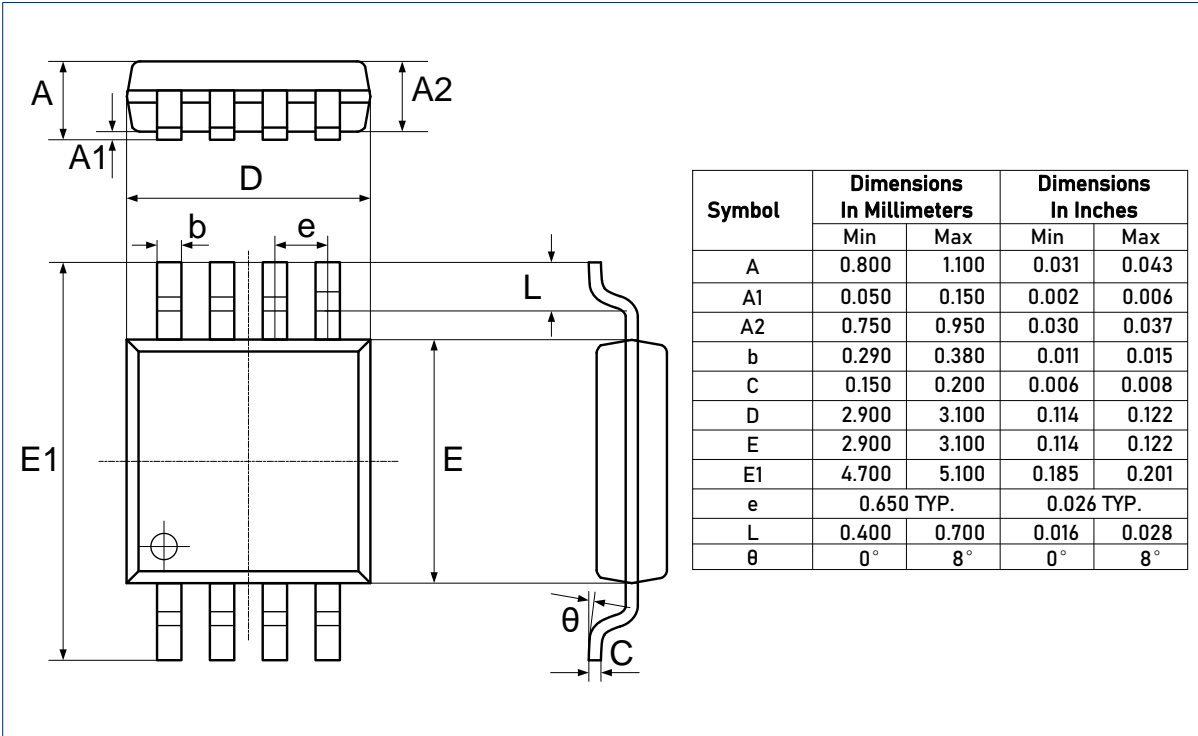

RECOMMENDED SOLDERING FOOTPRINT, MSOP-8L

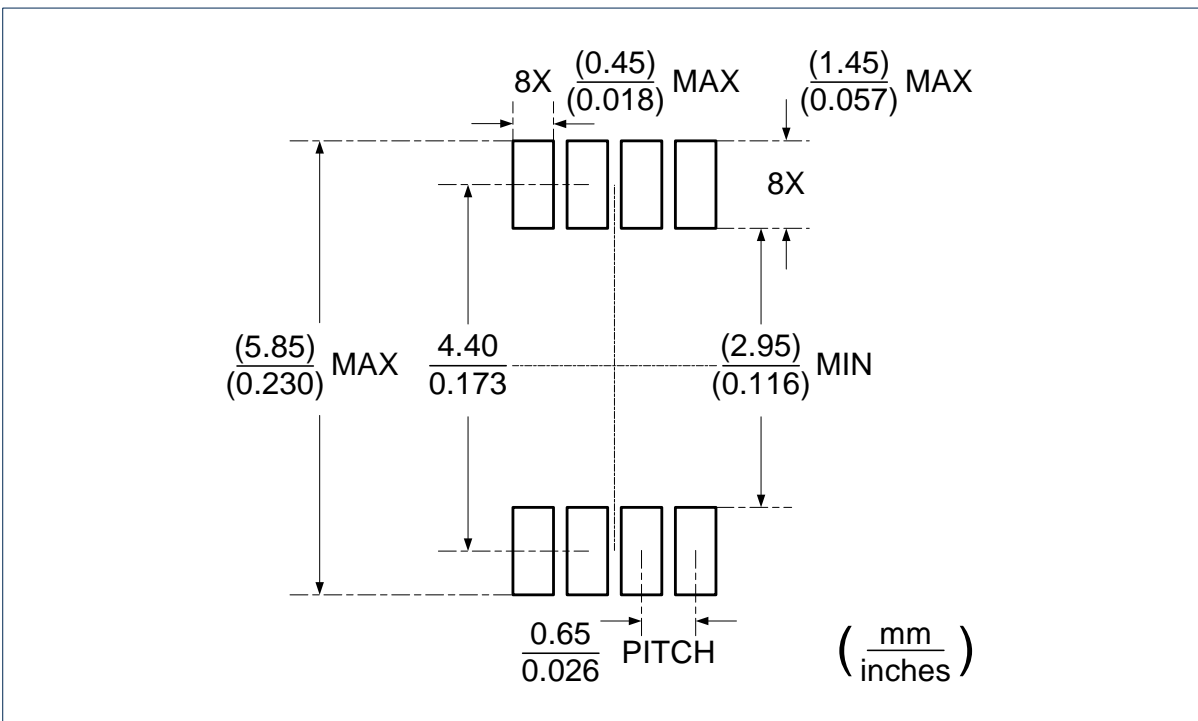

CAUTION: These devices are sensitive to electrostatic discharge; follow proper IC Handling Procedures. Linearin and designs are registered trademarks of Linearin Technology Corporation. © Copyright Linearin Technology Corporation. All Rights Reserved. All other trademarks mentioned are the property of their respective owners.

Important Notice

Linearin is a global fabless semiconductor company specializing in advanced high-performance high-quality analog/mixed-signal IC products and sensor solutions. The company is devoted to the innovation of high performance, analog-intensive sensor front-end products and modular sensor solutions, applied in multi-market of medical & wearable devices, smart home, sensing of IoT, and intelligent industrial & smart factory (industrie 4.0). Linearin's product families include widely-used standard catalog products, solution-based application specific standard products (ASSPs) and sensor modules that help customers achieve faster time-to-market products. Go to <http://www.linearin.com> for a complete list of Linearin product families.

For additional product information, or full datasheet, please contact with the Linearin's Sales Department or Representatives.